



ISOACOUSTICS®

Sound quality by design

V120 Mount

Ceiling and wall
isolation mount
for studio monitors



Installation Guide

*For video instructions on how to install the V120 Mount,
please use the QR code or shortened URL listed below.*



Shortened URL code
<https://qrco.de/bdKLk0>



Congratulations on your purchase of the V120 Isolation Mount from IsoAcoustics!

The IsoAcoustics V120 features a unique, low profile isolation module that adapts to wall and ceiling applications, offering the acclaimed acoustic isolation performance that the company's multiple award-winning products have become known for. The V120 compliments professional audio speakers to provide remarkable clarity and openness.

This V120 Mount is easily installed for wall and ceiling applications using IsoAcoustics mounts or adapting to other third-party mounts and assemblies including truss and Unistrut channel. Using the V120 Mount, studio monitors can be oriented to be facing forwards or downwards and can be tilted to allow easy adjustment for focusing monitors.

Mounting Adapters and Brackets are sold separately

Adapters and brackets are available for common studio monitors weighing 40 lbs or less. The online [Product Selector](#) provides an easy reference to determine which components are required to configure a Make/Model studio monitor for a wall or ceiling installation using IsoAcoustics or other third-party mounts.



Product Selector

Determine the right adapters for your studio monitor
calculator.isoacoustics.com

Safety Warnings

When using this product, basic safety precautions should always be followed to reduce the risk of injury, including the following:

 DANGER Risk of falling! Take special care when working at height. Use safety equipment.

- Read this installation guide very carefully and pay attention to the information contained within, before installing the V120 Mount
- Installation should be carried out by trained installation personnel
- Only install on ceilings and structures that are suitable to support the combined weight of the V120 Mount and studio monitors
- Follow the instructions and guidelines provided by the fastener/anchor manufacturer. Ensure that the fasteners and anchors are rated to support the weight of the V120 Mount and studio monitors
- Do not mount on ceilings and walls that are too weak or have electric or plumbing lines
- Pay attention to tight screw connections, especially when making adjustments
- The V120 Mount is intended for indoor installation only
- Careful handling required due to adjustment options

Specification

- Dimensions (W x H x D) - 117 x 98 x 117 mm (4.61 x 3.86 x 4.61")
- Weight - 0.77 kg (1.7 lbs)
- Max loading capacity - 18.1 kg (40 lbs)
- Material - Aluminum

Table of contents

| | |
|--|----|
| Introduction..... | 1 |
| Safety warnings | 2 |
| Specification..... | 2 |
| Table of contents..... | 3 |
| Scope of delivery..... | 3 |
| 1. Additional equipment..... | 4 |
| 2. Structure of the V120 Mount..... | 6 |
| 3 Disassembly of the V120 Mount..... | 7 |
| 3.1 Dismantling the ceiling plate..... | 7 |
| 3.2 Dismantling the bottom circular flange..... | 7 |
| 4 Mounting the V120 Mount to the ceiling, wall or other structure..... | 8 |
| 4.1 Mounting to the ceiling..... | 8 |
| 4.2 Mounting to the wall..... | 10 |
| 4.3 Mounting to the truss..... | 11 |
| 4.4 Mounting to the Unistrut channel..... | 12 |
| 4.5 Third party hardware..... | 13 |
| 5 Mounting studio monitors to the V120 Mount..... | 14 |
| 5.1 Studio monitors with mounting threads located on the back..... | 14 |
| 5.1.1 Rotate and tilt studio monitors..... | 16 |
| 5.2 Studio monitors with mounting threads located on the sides..... | 18 |
| 5.2.1 Rotate and tilt studio monitors..... | 19 |

Scope of delivery



V120 Mount
(Qty 1)



Allen key 5mm
(Qty 1)

1 Additional equipment

Additional equipment allows you to freely configure the mounting of your studio monitor. Additional equipment are sold separately.

V120 Ceiling Plate
(included)



IsoAcoustics Wall Bracket



Keyhole Adapter
(adapt to third party mount)



***Truss Clamp**



***Unistrut Channel Nut**



V120 Mount



U-Bracket Adapter

L-Bracket

C-Bracket



**U-Bracket
Adapter**



***U-Bracket**



***Studio Monitor**



L-Bracket



C-Bracket



T-Adapter



107x50-Adapter



50x107-Adapter



***Studio Monitor**



***Third party product**

2 Structure of the V120 Mount

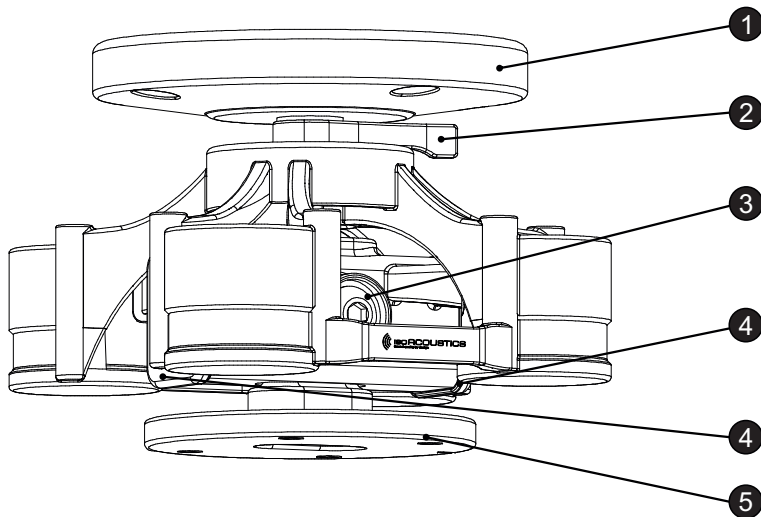

Legend

- 1. Ceiling plate
- 2. Tightening arm
- 3. Locking screw
- 4. Cap
- 5. Circular flange

3 Disassembly of the V120 Mount

3.1 Dismantling the ceiling plate

1. Loosen the tightening arm

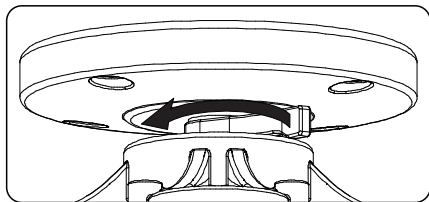

2. Unscrew the ceiling plate

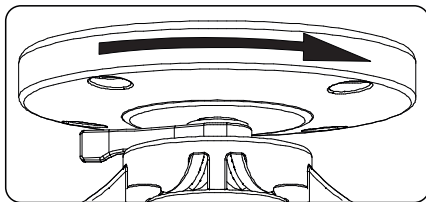

3.2 Dismantling the bottom circular flange (when circular flange is not required)

1. Unscrew both bolts with an Allen key

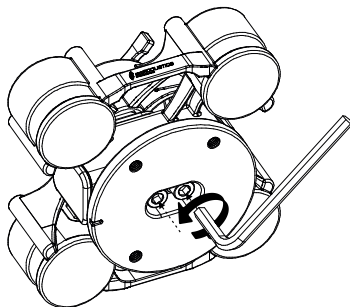

2. Remove the bottom circular flange

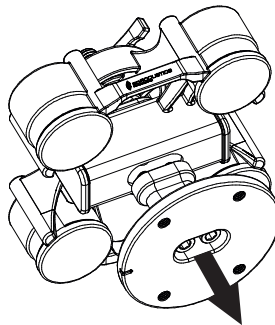

4 Mounting the V120 Mount to the ceiling, wall or other structure

4.1 Mounting to the ceiling

Important: Fastening screws/anchors are not included in the scope of delivery, because the type of fastening should be properly selected for the type of ceiling. Fastening screws/anchors must be purchased suitable to the type of ceiling.

Use 4 screws/anchors for ceiling mounting, taking into account local mounting instructions/regulations (possibly deviating from the examples provided).

Ensure that the fasteners and anchors are rated to support the weight of the V120 Mount together with the studio monitor.

Do not mount on ceilings and walls that are too weak or have electric or plumbing lines.

Spacing and diameter of holes in the ceiling plate of the V120 Mount.

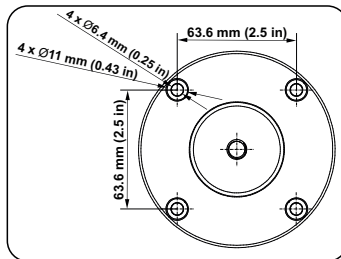

Manual marking of holes on the ceiling using ceiling plate.

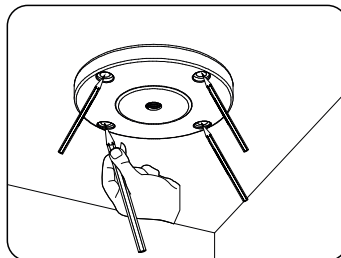

Installation

1. Remove the ceiling plate from the V120 Mount, as shown in chapter 3.1 „Dismantling the ceiling plate“.
2. Fasten the V120 isolator ceiling plate to the ceiling with dowels and screws or anchors (possibly deviating from the examples provided).
3. Screw in the V120 isolator into the installed ceiling plate.

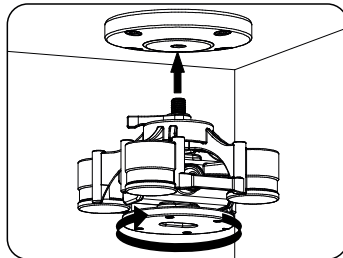
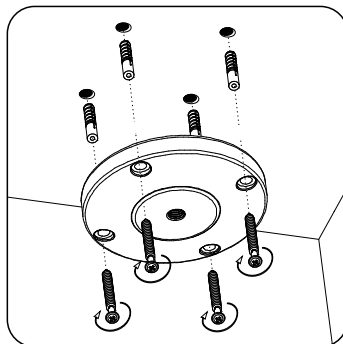

4. Secure the connection by tightening the tightening arm.

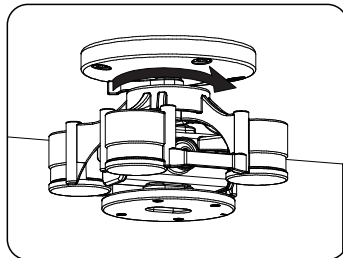

4.2 Mounting to the wall (IsoAcoustic Wall Mount Bracket sold separately)

1. Follow the instructions included with the IsoAcoustics Wall Mount Bracket to install IsoAcoustic Wall Mount Bracket.

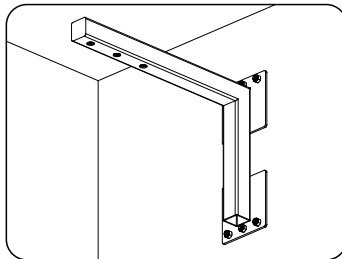

2. Remove the ceiling plate from the V120 Mount, exposing the top M10-1.5 thread as shown in chapter 3.1 „Dismantling the ceiling plate”.

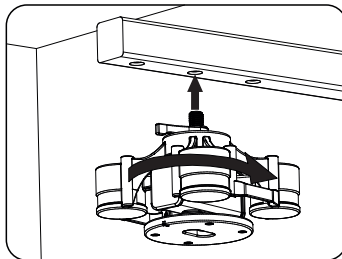

3. Install the V120 isolator into the IsoAcoustics Wall Mount Bracket by screwing the V120 isolator thread into the one of three threaded inserts in the IsoAcoustics Wall Mount Bracket.

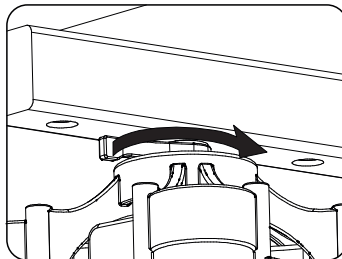

4. Secure the connection by tightening the tightening arm.

4.3 Mounting to the truss (Truss Clamp not included)

1. Remove the ceiling plate from the V120 Mount, exposing the top M10-1.5 thread as shown in chapter 3.1 „Dismantling the ceiling plate”.

2. Install a Truss Clamp (not included) on the M10-1.5 male thread at the top of the V120 isolator.

3. Secure the connection by tightening the V120 isolator tightening arm.

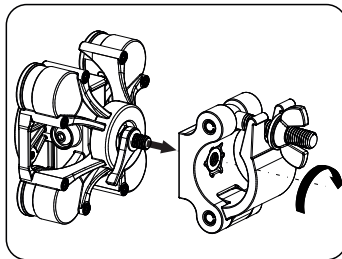

4. Install the Truss Clamp with the V120 isolator on the truss.

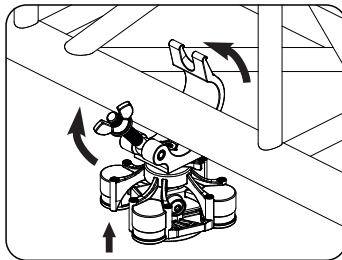

5. Fold the clamp together and tighten the wing nut. Make sure it is tightened correctly.

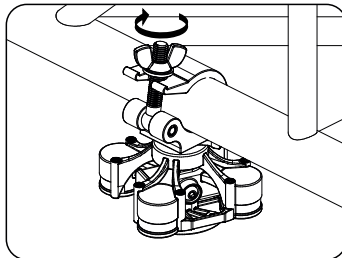

4.4 Mounting to the Unistrut channel (Unistrut Channel Nut not included)

1. Remove the ceiling plate from the V120 Mount, exposing the top M10-1.5 thread as shown in chapter 3.1 „Dismantling the ceiling plate”.

2. Install an Unistrut channel M10 nut in the Unistrut channel and position it at the final location for the studio monitor.

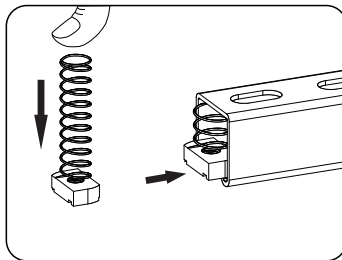

3. Install the V120 isolator into the Unistrut channel nut by rotating the V120 isolator. Apply a large M10 washer between channel threaded nut and V120 isolator.

Large M10 washer example:

www.mcmaster.com/99041A141

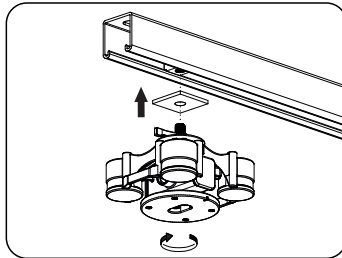

4. Secure the connection by tightening the tightening arm.

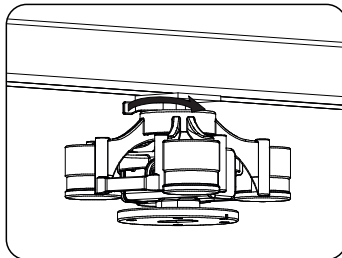

4.5 Third party hardware (Keyhole Adapter sold separately)

The V120 Mount is adaptable to many third party mounts and hardware using the Keyhole Adapter. Please visit isoacoustics.com for further information.

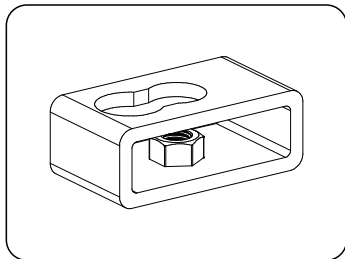

Notes

5 Mounting studio monitors to the V120 Mount

5.1 Studio monitors with mounting threads located on the back Brackets and Adapters are required (sold separately)

1. Depending on your preferences and purpose, you can use different types of brackets.
If using the L-Bracket, follow the instructions included with the L-Bracket to adjust the height of the bracket.



L-Bracket

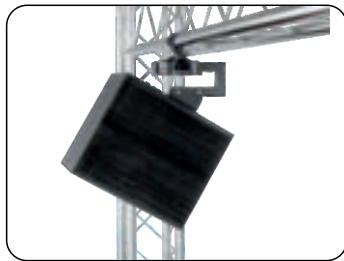

C-Bracket

2. Mount the appropriate adapter for your studio monitor to the mounting bracket using the hardware included. Adapters and mounting brackets are sold separately.
To determine the correct adapters for your studio monitors, use the IsoAcoustics Product Selector at calculator.isoacoustics.com.
3. Fasten the adapter to the threads on the back of the studio monitors using the included bolts. Bolts might need to be purchased separately if a different size or length is required.

T-Adapter



107x50-Adapter



50x107-Adapter



To mount the V120 isolator to the studio monitor with the bracket installed, follow the steps below.

1. Remove the bottom circular flange from the V120 Mount using the Allen key included, as shown in chapter 3.2 „Dismantling the bottom circular flange”.
2. Remove both caps from the V120 Mount.
3. Loosen the locking screw located on the side of the V120 Mount using the Allen key included.

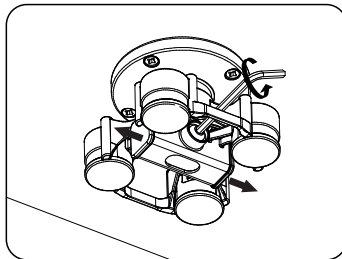

4. Slide the mounting bracket with the studio monitor into the V120 Mount. Rotate the V120 Mount if required to avoid any obstructions. (For example, if the V120 Mount is close to a wall, the wall might get in the way when trying to install the bracket/monitor.)

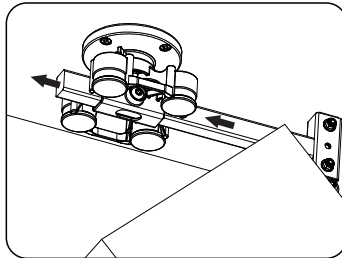

5. Adjust the position on the slide so that the weight of the studio monitor is properly balanced underneath the V120 Mount and then tighten the locking screw.

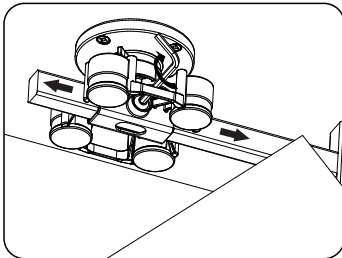

5.1.1 Rotate and tilt studio monitors

To rotate

1. Loosen the tightening arm to rotate the V120 isolator with studio monitor mounted.

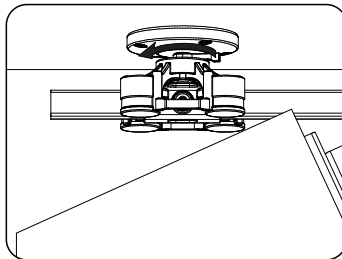

2. Position the studio monitor in the correct position by turning the V120 isolator with the studio monitor mounted.

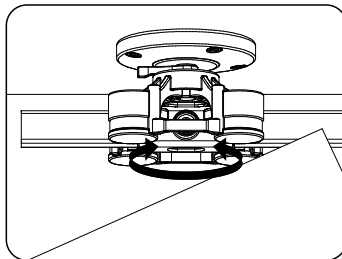

3. Tighten the tightening arm.

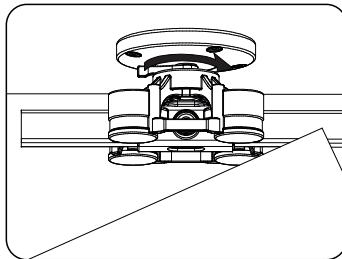

To tilt

1. While supporting the studio monitor, carefully loosen both nuts and bolts on the tilt adjuster located on the mounting bracket using the M10 wrench included with the bracket.

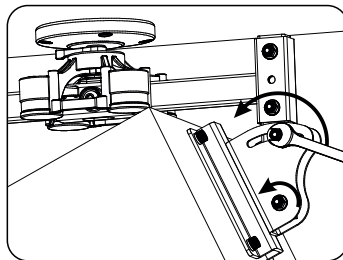

2. Adjust the tilt angle of the monitor and then tighten the nuts and bolts.

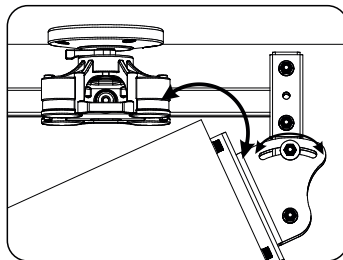

3. Adjust the position of the slide in the mounting bracket so that the weight of the monitor is balanced underneath the V120 Mount. See chapter 5.1 „Studio monitor with mounting threads located on the back” for loosening and tightening the locking screw located on the side of V120 Mount.

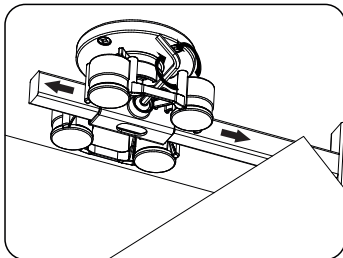

5.2 Studio monitors with mounting threads located on the sides

A third party U-Bracket and the IsoAcoustics U-Bracket Adapter is required (sold separately)

1. Follow the instructions included with the U-Bracket Adapter to attach the U bracket Adapter to the V120 Mount circular flange and the U-Bracket Adapter Insert to the appropriate U-Bracket designed for your studio monitor.

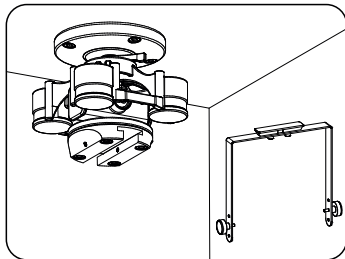

2. Follow the instructions included with the U-Bracket to attach the U-bracket to the studio monitor.

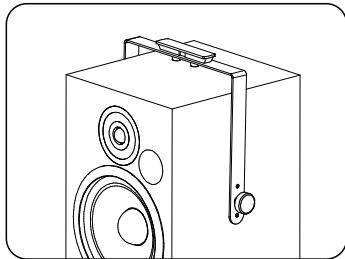

3. Slide-in the U-Bracket Insert into the U-Bracket Adapter and lock it in place by tightening the both set screws on the U-Bracket Adapter.

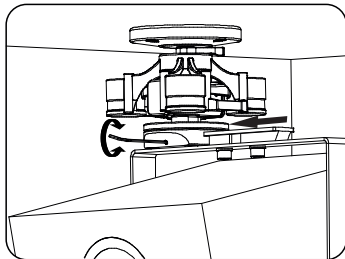

5.2.1 Rotate and tilt studio monitors

To rotate

1. Loosen the tightening arm to rotate the V120 isolator with studio monitor mounted.

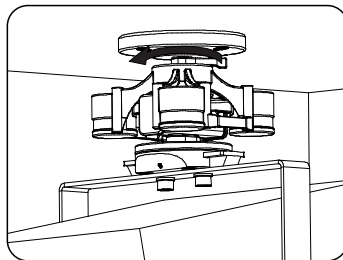

2. Position the studio monitor in the correct position by turning the V120 isolator with the studio monitor mounted.

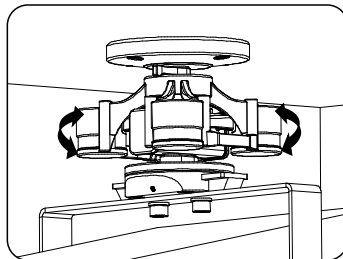

3. Tighten the tightening arm.

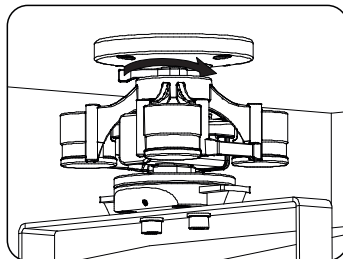

To tilt

1. Loosen both fasteners on the sides of the studio monitor that are attaching the U-Bracket to the studio monitor.

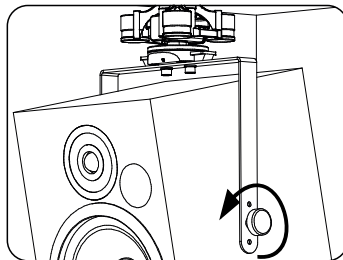

2. Adjust the tilt angle of the studio monitor.

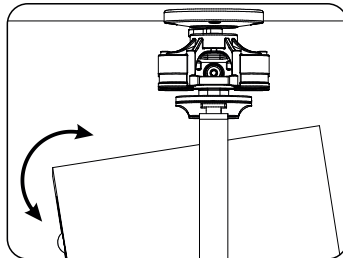

3. Tighten both fasteners.

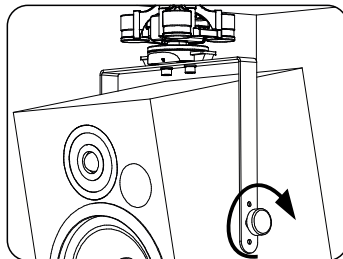

*For video instructions on how to install the V120 Mount,
please use the QR code or shortened URL listed below.*



Shortened URL code
<https://qrco.de/bdKLk0>



IsoAcoustics Inc.
39 Main street North, Unit 5
Markham, ON, Canada L3P 1X3
www.isoacoustics.com

© IsoAcoustics Inc. 2022

Published 09/2022

IG-09/2022-00